

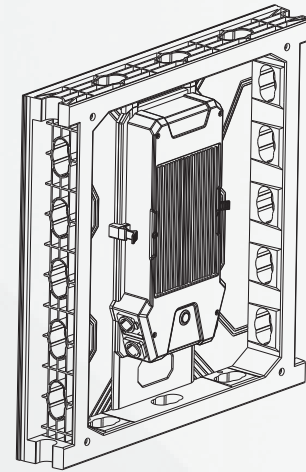

MG7S/MG7S Pro Series LED Screen User Manual



HQ address : Office - 414, Business Avenue Bldg.
Port Saeed, Dubai, UAE
Tel : +971 4 365 8444
Phone / WhatsApp : +971 50 2244 390
Web: www.orexled.com
E-mail: info@orexled.com

CONTENTS

CAUTION	01
PREFACE	06
Chapter 1 LED Cabinet	07
1.1 Cabinet Structure	07
Chapter 2 Cabinet Connection	08
2.1 Connectors and Cabinet Mounting Socket Connection	08
2.2 Signal and Power Cable Connection	10
Chapter 3 LED Screen Installation	12
3.1 Hanging Installation	21
3.2 Fixing Installation	27
3.3 Curving Installation	28
3.4 Dislocation Installation	30
3.5 Dance Floor Installation	32
Chapter 4 Frequently Questions For LED Screen	40
4.1 Software Questions	40
4.2 Hardware Questions	41
Chapter 5 LED Screen Maintenance	42

CAUTION

Warning: This is a CALSS A-level product. In the living environment, this product may cause radio interference. In this case, the user may be required to take practical actions for the interference.



Caution 1:

In order to avoid any physical damage, please read carefully the User Manual before connecting the switches.

1. LED screen should only be operated by trained professionals.
2. Do not expose any part of the LED screen to naked flame/smoke.
3. Personnel operating the LED screen are advised to wear a safety helmet during operation.
4. Check all the AC power is connected before turning on the switch.
5. Turn off all switches of the LED screen, computer terminals, system box and monitors before performing any maintenance work.
6. Do not touch the power supply when the switch is turned on.

Caution 2:

Please read the installation and operation instruction manual carefully in order to make sure the normal lifespan of LED screen and avoid any damage of electronic components, device driver and loss of data.

1. Turn off all switches including LED screen, computer terminal, system box and monitor before connecting any cables.
2. Wear Anti-static ring before replacing any electronic components.
3. Do not hot plug any cables connected to computer terminals while the power is running. Ensure that all power is disconnected before unplugging any cable from the ports especially the serial line ports.
4. Avoid the cabinet work under the conditions of high organic solvent detergent (such as kerosene, rust-proof oil, etc).
5. Regular electricity testing is required for indoor LED screen if long time no use. (regular electricity testing standard: at least 2 hours in a week increase gray scale stepwise)
6. The operating/storage environment should conform to the requirements in product parameter&specification sheet, otherwise it will damage the LED screen seriously.
7. In order to ensure the safety, please check the condition of power cables every three months if rental usage, every year if fixing installation.

Caution3:

1. Making sure the LED screen should be properly grounded before working.
2. LED screen grounding resistance must be less than 1Ω .
3. If the LED screen is equipped with flight cases, the flight cases should not be exposed to rain. After each performance is completed, please pay attention to the moisture-proof treatment of the flight cases.

Caution 4:

1. Warnings regarding to the CE certification: This equipment is compliant with Class A of CISPR 32. In a residential environment this equipment may cause radio interference.
2. Warnings regarding to the FCC certification: This device complies with Part 15 of the FCC Rules. Operation is subject to the following two conditions: (1) this device may not cause harmful interference, and (2) this device must accept any interference received, including interference that may cause undesired

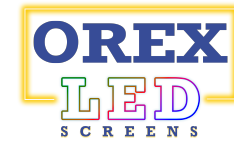

operation.

Warning: Changes or modifications to this unit not expressly approved by the party responsible for compliance could cause the user can not to operate the equipment.

NOTE: This equipment has been tested and found to comply with the limits for a Class A digital device, pursuant to Part 15 of the FCC Rules. These limits are designed to provide reasonable protection against harmful interference in a residential installation. This equipment generates, uses and radiate radio frequency energy and, if not installed and used in accordance with the instructions, may cause harmful interference to radio communications. However, there is no guarantee that interference will not occur in a particular installation. If this equipment does cause harmful interference to radio or television reception, which can be determined by turning the equipment off and on, the user is encouraged to try to correct the interference by one or more of the following measures:

- Reorient or relocate the receiving antenna.
- Increase the separation between the equipment and receiver.
- Connect the equipment into an outlet on a circuit different from that to which the receiver is connected.
- Consult the dealer or an experienced radio/ TV technician for help.

Caution 5:

Pay attention to the use of floor cabinets:

1. Avoid metal sharps, shoe spikes, glass and other hard objects from scratching or hitting the floor;
2. Do not drag on the surface when moving heavy objects.
3. When the vehicle passes through the ramp pad, the speed of the vehicle should be slow and gentle, and can not accelerate rapidly.
4. When water enters between the mask of floor cabinets and the lamp surface, the mask should be removed to allow the water to dry naturally or with a fan;
5. When the cabinet maintained, if disassemble the cabinet mask, after finishing maintenance, the screw use for fasten the mask cannot higher than the brim.
6. After use, please clean the sand and water stains on the surface of the mask of floor cabinets before putting it back into the air box.

Notice 6

Attention of P3.9 mask's using:

1. P3.9 outdoor are adopting two types full viewing angle mask which includes U shaped and dotted type, and both models include the masks of interactive functions.
2. Comparing with the dotted full viewing angle mask, the U shaped model has a better led protection ability, but with lower viewing angle; Comparing with the ordinary mask with shader, the viewing angle of U shaped model is much better.
3. The U shaped masks are mainly used to the rental customers who don't have special requirements of the viewing angle and need to repeatedly change different applications.
4. Comparing with the U shaped full viewing angle mask, the dotted model has a weaker led protection ability, but with better viewing angle, especially the viewing angle of 45°. Comparing with the ordinary mask with shader, the viewing angle of the dotted model is much better.
5. The dotted model is competitive for the customers who have high requirements of the viewing angle and don't need to repeatedly change the applications, like fixed installation project, sky curtain and dance floor.
6. The dotted masks with anti-slide function are especially used to dance floor project that add tempered glass on the front surface of the cabinet; The surface of the mask has an added anti-skid damping function, which greatly reduces the phenomenon of the glass cover sliding on the surface of the cabinet, combined with the special dance floor rubber pad, it can better protect the tempered glass cover from colliding with each other and breaking.

Special statement:

Our company does not compensate for the personal injury or material loss caused by the users' arbitrarily transforming or repairing this product. Please contact our company beforehand when it is needed to repair or remould the product.

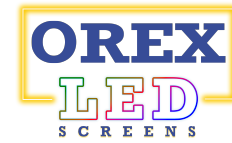

Warranty period:

- ◎ In principle, the product warranty period is based on the product warranty period specified on the quotation.
- ◎ During the warranty period, our company will not guarantee any problems due to the following reasons.
 - Problems caused by the user's arbitrarily dismantling the product or failing to perform maintenance properly.
 - Problems caused by incorrect transport and storage.
 - Problems caused by the use of exceeding the rated parameters of the product.
 - Problems caused by improper installation.
 - Problems caused by fires, earthquakes, storms, floods, lightning and other natural disasters or riots, wars, radioactivity, etc. and other natural and man-made disasters.

Signs of restricted use of hazardous substances in electrical and electronic products:



1. The logo indicates that the environmental protection use period of electronic and electrical products is 10 years;
2. It means that the electrical and electronic products contain certain hazardous substances and can be used with confidence within the environmental protection use period. After the environmental protection period is exceeded, they should enter the recycling system.

PREFACE

Magic stage MG7S series cabinet adopts the high Polymer nanomaterial, it is very light and thin, only 7kg per cabinet.

The product's consistency is better, and the anti-corrosion and waterproof performance are stronger than traditional metal plated cabinet. The installation is faster and more humanization. The aluminum alloy heat sink and power supply box are designed as a one body, injection molding, which greatly improved heat dissipation performance. The refresh rate can up to 3840Hz. Due to high refresh rate, image will not show dark streaks and flashes when being captured by camera. With limitless display size, high brightness and curve installation, which can meet more market demands and broaden more application, our screen has become an important choice for stage show/rent, exhibitions, shows and commercial advertising. Also, using different accessories, Magic Stage can easily achieve multi-function like perimeter Screen, dance floor, sky curtain, and all the creative design.

To ensure that our products are used within reasonable conditions and get your recognition, we will explain installation process, using process and cautions in details. Please read this carefully before installing and testing screen.

Chapter 1 LED Cabinet

The LED cabinet mainly includes power supply, modules, and receiving card.

1.1 Cabinet Structure

The cabinet structure of MG7S series products is made of high polymer nanomaterial instead of the traditional aluminum alloy die-castings or steel material so that the cabinet weight is much lighter.

The cabinet size is 500mm*500mm*73mm. (Figure 1.1.1)

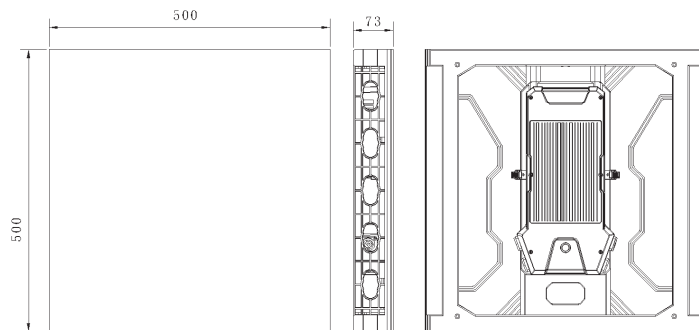

Figure 1.1.1 Cabinet view from all sides

Chapter 2 Cabinet Connection

2.1 Connectors and Cabinet Mounting Socket Connection

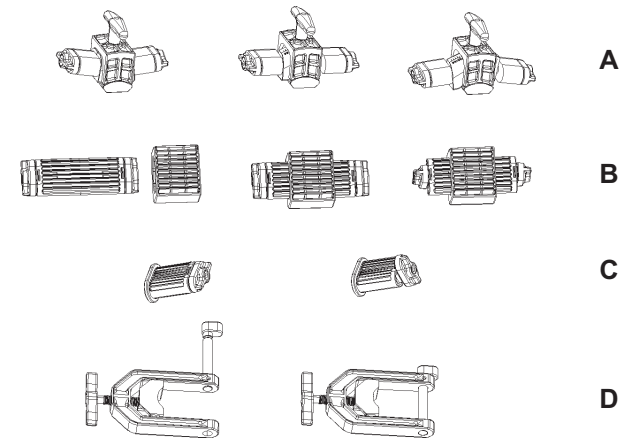

Figure 2.1.1 Connectors for cabinet

As shown in Figure 2.1.1. A(curve connector), B(horizontal connector), C(vertical connector) and D (U-shape structure connector) are the connectors for cabinets. The connectors are used to join and fix the cabinets. Connectors A and B are used to connect the cabinets horizontally, while connector C is used to connect the cabinets vertically. Connector A is used for curving installation. After two cabinets are connected, they can be twisted, or stretched forth or back to form a cambered surface. Connector D is mainly used for fixing installation.

The maximum horizontal bearing capacity of Connector A is 500 N, the safety bearing capacity is 200 N. It can be used more than 2000 times, and stored more than 3 years;

The maximum horizontal bearing capacity of Connector B is 1500 N, the safety bearing capacity is 500 N. It can be used more than 2000 times, and stored more than 3 years;

The maximum vertical bearing capacity of Connector C is 7000 N, the safety bearing capacity is 1200 N. It can be used more than 2000 times, and stored more than 3 years.

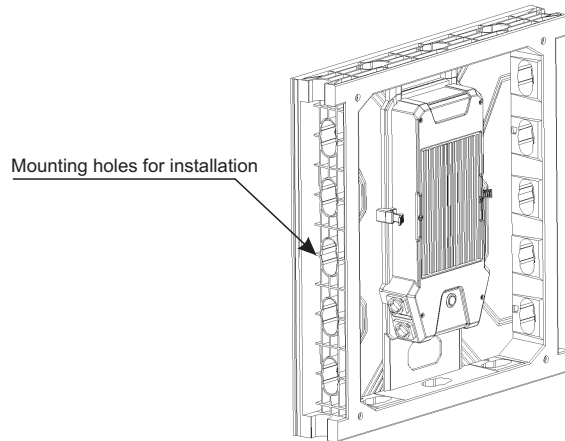

Figure 2.1.2 Mounting sockets of the cabinet

As shown in Figure 2.1.2, there are 3 mounting sockets and 2 half mounting sockets on the top and bottom of the frame. 5 mounting sockets on left and right side of the frame, where the connectors can be inserted. Tightly twist the end of the connectors to lock the cabinets in place. One by one, the cabinets can be connected easily and fast with “one slot and one twist”.

Please note: Our standard issue of the connectors would be 2 vertical connectors(C) and 3 horizontal connectors(B) as shown in Figure 2.1.3.

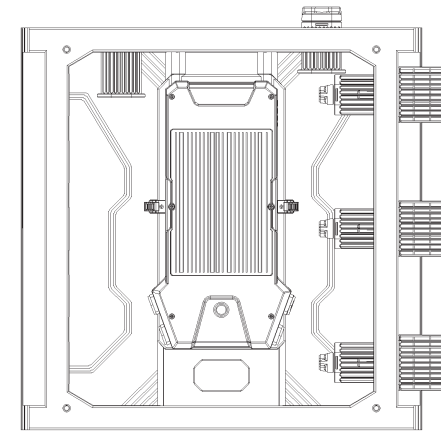

Figure 2.1.3 Standard connectors for cabinet

2.2 Signal and Power Cable Connection

Adopting Cat5 cable (signal cable) (Figure 2.21) and power cable (Figure 2.2.2) to connect each cabinets. MG7S standard cabinet using two cables fixing on the cabinet, one signal cable and one power cable. The signal transmit between the first cabinet of the screen and the sending card end(PC,video processor, etc) use the long signal cable; the signal transmit between cabinet and cabinet use short fixed signal cable.

One cabinet be connected by 2 signal cables, one port input and one port output, the input signal of the cabinet comes from the last cabinet output signal, the output signal of the cabinet connect next cabinet input signal, this connection way is as same as power cable.

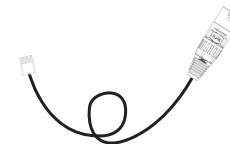

Figure 2.21 Cat5 Cable (signal cable)

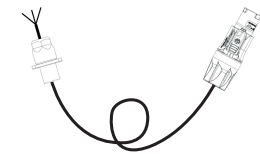

Figure 2.2.2 Power cable

Chapter 3 LED Screen Installation

For LED screen installation, we provide customers Five methods: hanging installation, fixing installation, curving installation, dislocation installation and dance floor installation. Customers can choose an appropriate installation style according to the situation.

Note 1:

All installation methods are required to avoid collision of the frontage 4 corners of the cabinet (as Figure 3.1), causing unnecessary damage and affecting the normal use of the cabinet.

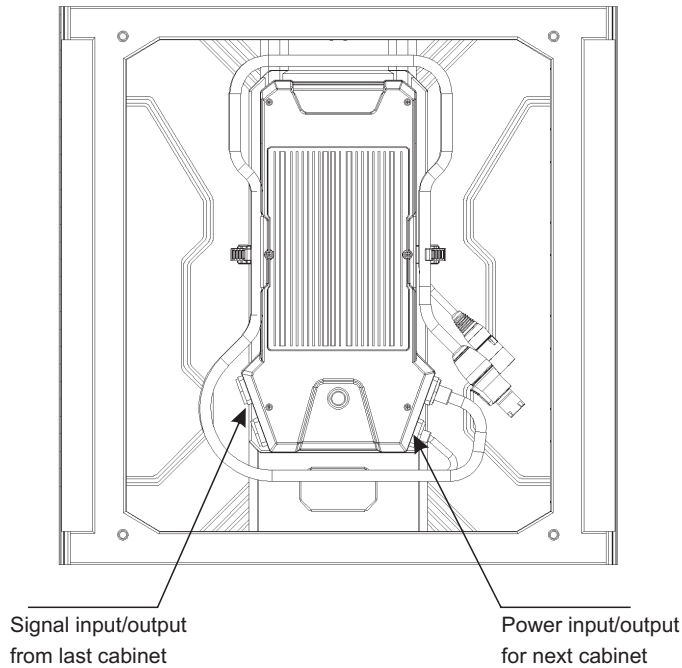

Figure 2.2.3 Signal cable and power cable connection between cabinets

The both signal ports can be flexibly as input or output according to your actual operation, as shown in Figure 2.2.3.

The signal line source is sending card end, including the PC with the sending card, control box, the video processor with sending card.

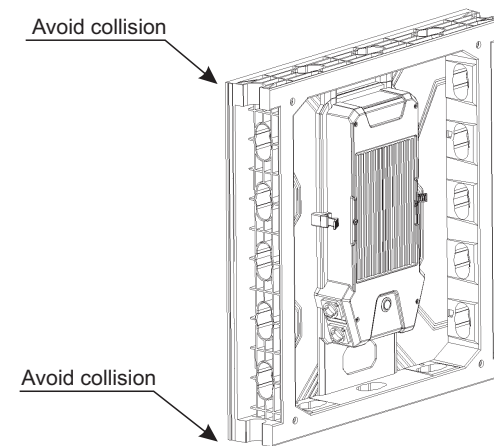

Figure3.1 Cabinet front corners

Note 2:

When taking out cabinets from flight case, make sure the cabinets remain level and in a steady speed. Avoid any possible friction between the flight case clapboard and the cabinet if the cabinet inclined (Figure 3.2), which will affect the outlook and performance of the cabinet. When using Flight case open from top, please be noticed the installation method (Figure 3.2), when you put the cabinet into flight case, the first row and last row need to be put opposite, both towards the interior of the flight case, to prevent damage to the lamp surface during transportation.

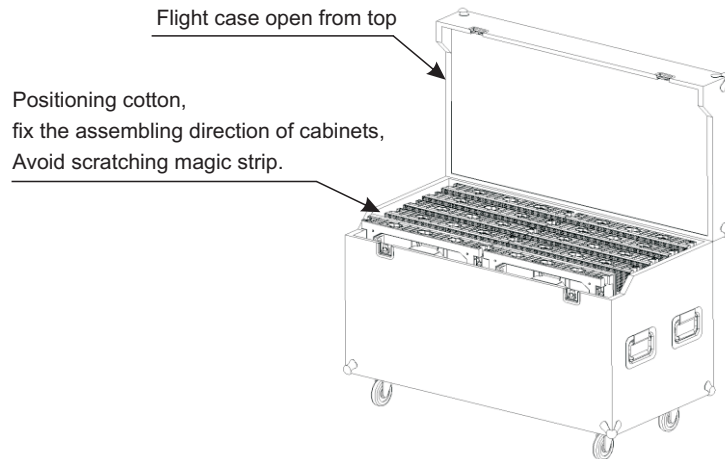

Figure 3.2 Taking out cabinets from flight case

Note 3:

In general, unused cabinets must be placed in flight cases or carton. However, in case of no flight cases or in other special conditions, the LEDs should be placed upwards, separating cabinets with foam or soft paper and when stack (stacked layers ≤ 10 PCS cabinet). Prohibit placing cabinet upright, in line of dominoes form (Figure 3.3).

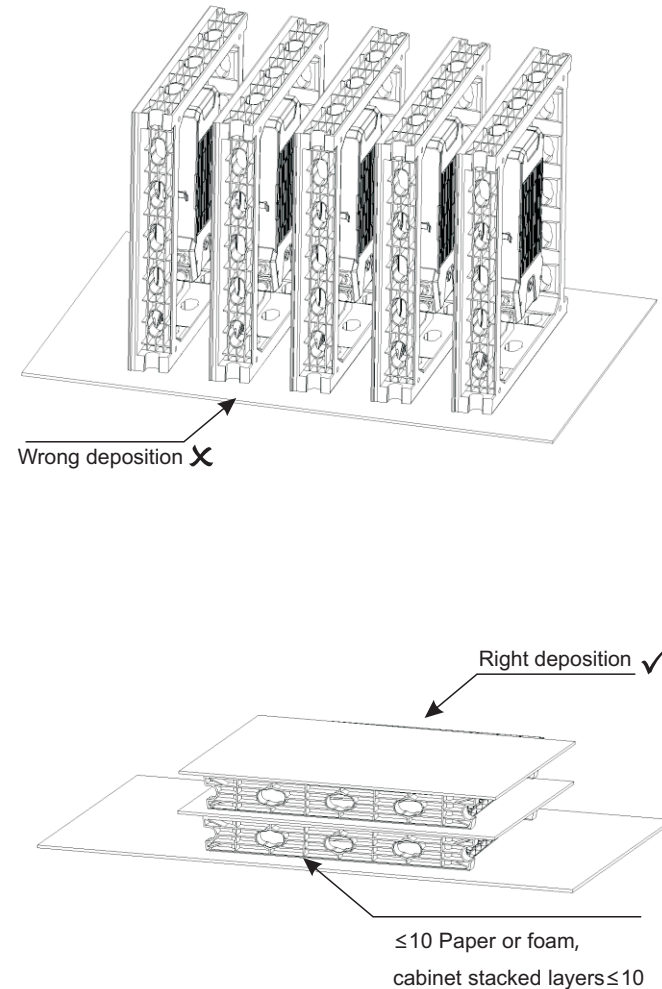
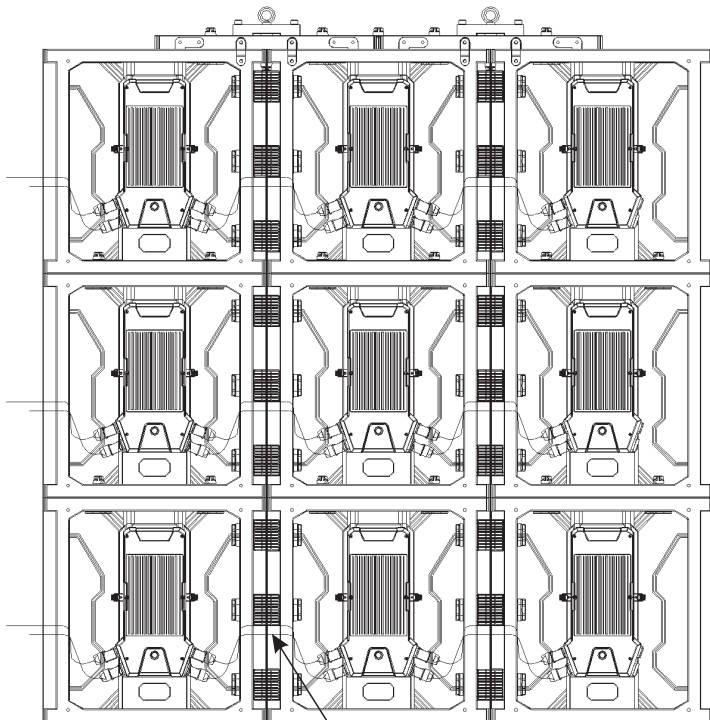

Figure 3.3 Cabinet deposition

Note 4:

When make the cascade connection of power cable and signal cable, in order to ensure the cables in queue and beautiful, cables between two cabinets can be connected through the mounting hole. After finishing the cascade connection of power cable and signal cable, ought to be cover tightly the unused connector jack lid. (Figure 3.4)



Power cable and signal cable connection through mounting hole

Figure 3.4 Power cable and signal cable connection through mounting hole

Note 5:

When the event is finished, the LED cabinets should be kept into the flight case or other places, please arrange the power cable and signal cable as Figure 3.5, put the cabinet in the right place after cleaning it. Handle gently when put the cabinets into the flight case.

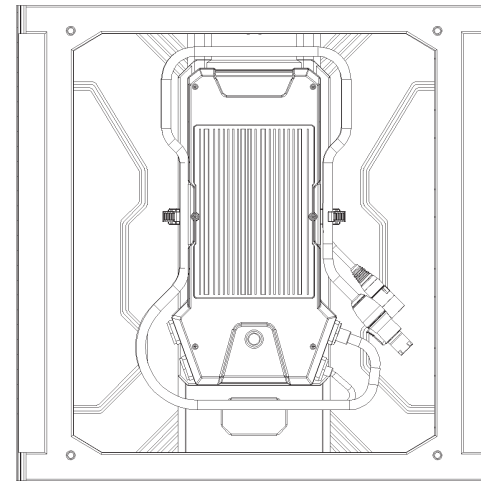

Figure 3.5 Cable putting

Note 6:

The cabinet can not be installed inclined (can not be above 45°) when cabinet used in outdoor, otherwise, there will have dropsy in mounting holes.

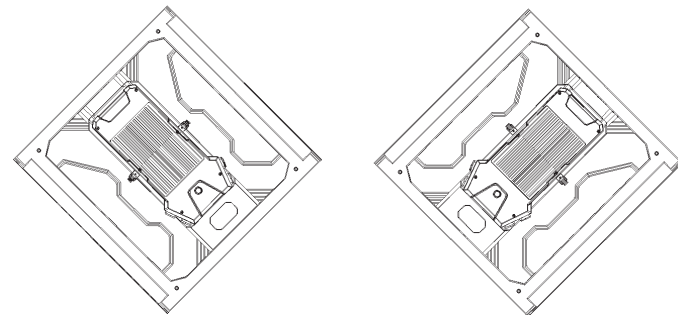

Figure 3.6 Cabinet can not be installed inclined (can not be above 45°)

Note 7:

As shown in Figure 3.7, there are 4 multi-functional holes in the four corners of the cabinets. When fixing installation, they are for electrostatic discharge(ESD), it's necessary to ensure that the structural parts(including trusses, steel frames, etc.) connected to the four holes are connected to the earth. When rental hanging installation, they are for fixing the plates between cabinets.

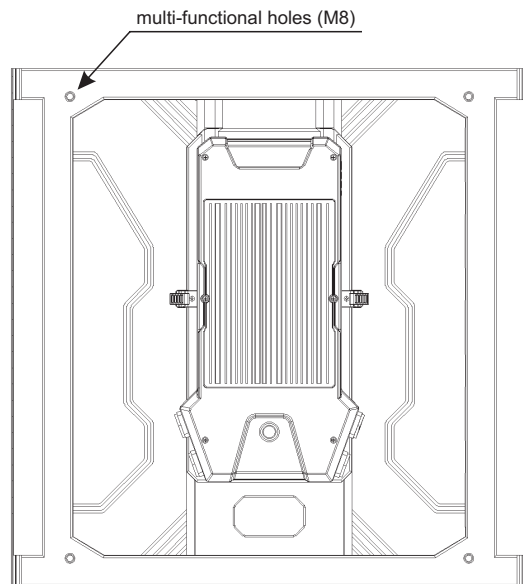

Figure 3.7 The diagram of position of multi-functional holes in the cabinet

Note 8:

When using all types of connectors, in order to ensure the maximum strength connection effect, the locking head needs to be screwed into right place, that is, the locking head and the connector itself are in a vertical state.

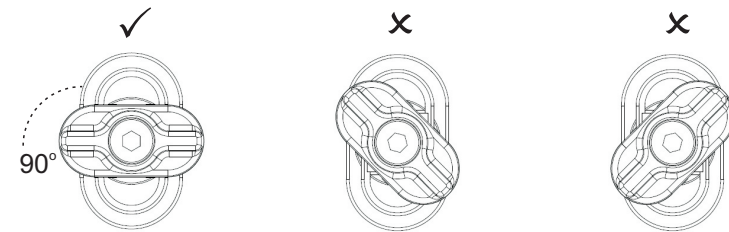
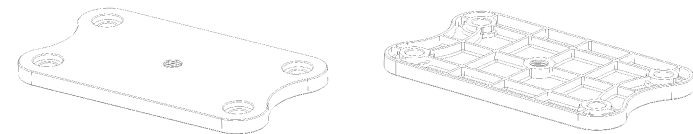

Figure 3.8 The using caution of the locking head of connector

Note 9:

In order to ensure the safe use of the cabinet and the better flatness of the LED screen, when the height of the hanging cabinet reaches $\geq 4\text{m}$ (eight cabinets' height), it is necessary to install the connecting piece, as shown in Figure 3.9.



the connecting piece

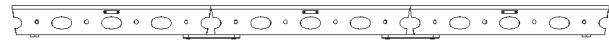

connecting piece
between the cabinet
and the hanging beam

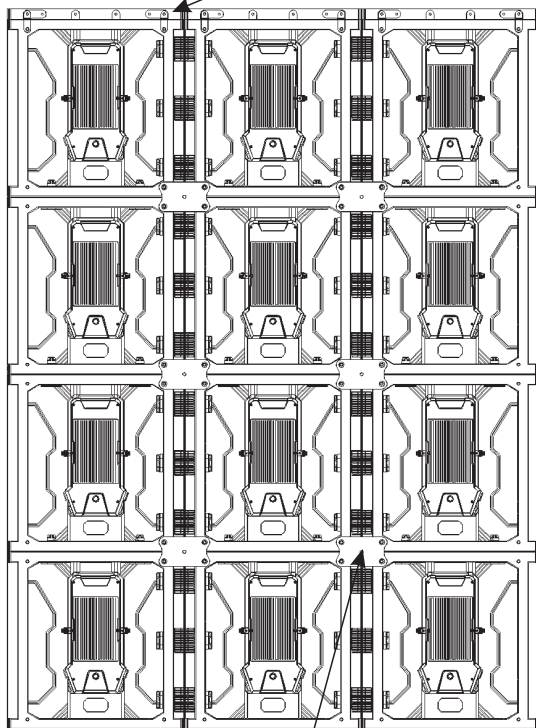

connecting piece between cabinets

Figure 3.9 The diagram of installation of connecting piece

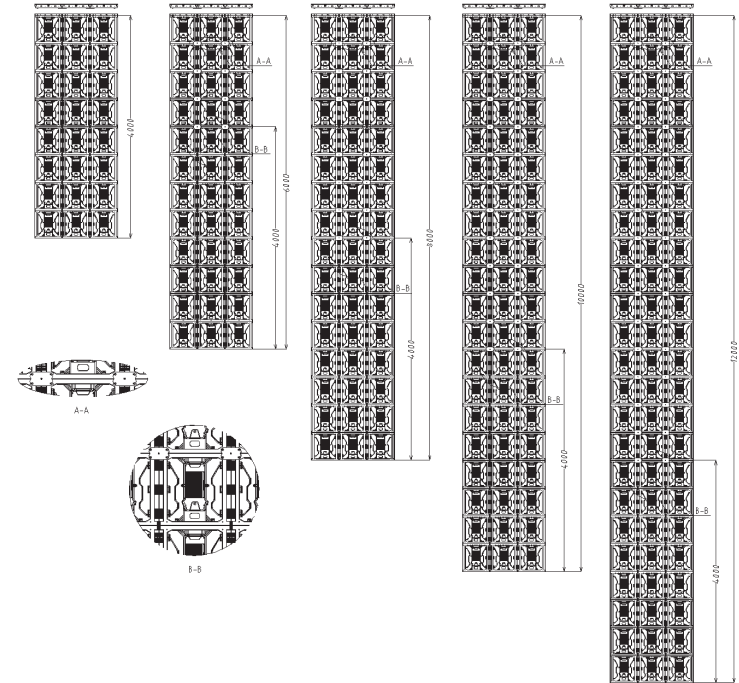

Figure 3.10 Hanging installation of 6m, 8m, 10m, 12m



Hanging height more than 12m,
please enhance the hanging structure or consult the technical

3.1 Hanging Installation

The hanging method is to hang the cabinet with the hanging beam. For such installation method, it must have a suitable installation location, such as overhead beams or lintel being present. Furthermore, it is necessary to have a cover at the back of the LED screen. To install in this way, it can also be mounted on TRUSS lifting frame or other similar firm structures, as Figure 3.1.1.2.

In this way, the uppermost of the screen is aluminum hanging beam, and below cabinets are connected, and then the lower cabinet is fastened with the upper one, and the right one connected with the left one, thus it can form a whole screen. The hanging beam structure as Figure 3.1.1.1, and the diagram of hanging beam mounted on the TRUSS frame with rope as Figure 3.1.1.2 and Figure 3.1.1.3. each complete hanging beam is made up of several short hanging beams with 3 holes. C-connectors should be installed between hanging beams.

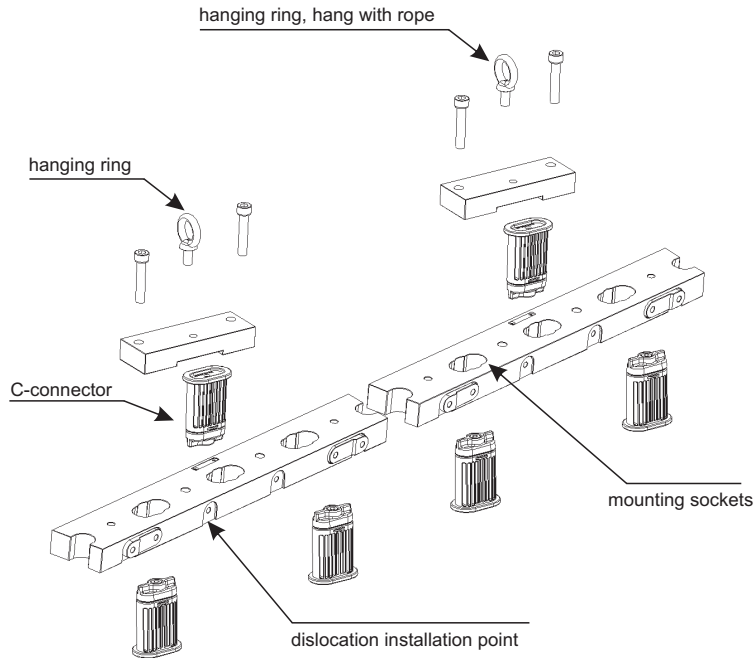

Figure 3.1.1.1 Aluminum Hanging beam installation diagram

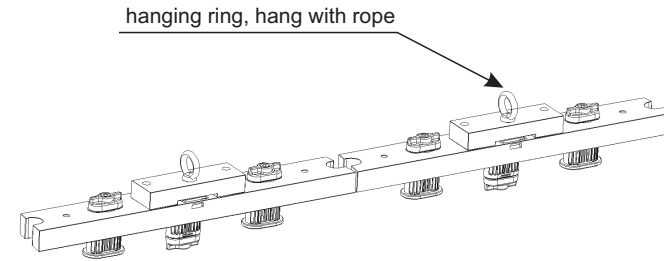

Figure 3.1.1.2 Aluminum hanging beam installation (rope and the TRUSS frame)

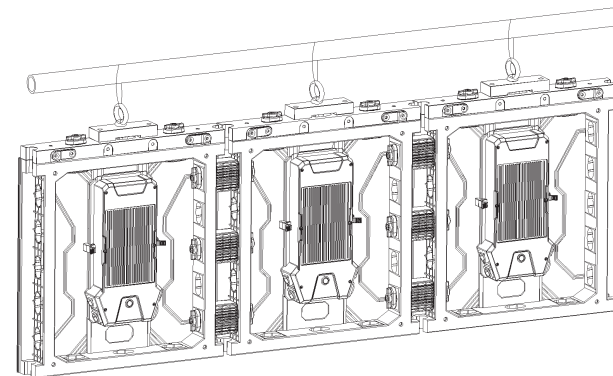
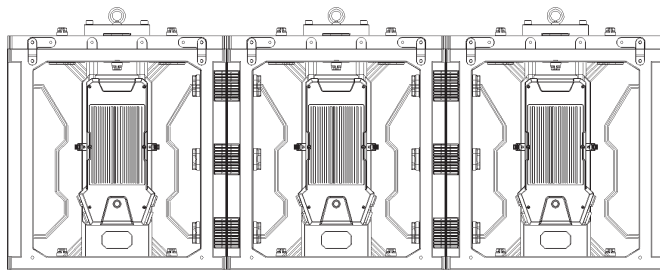

Figure 3.1.1.3 Hanging beam mounted on the TRUSS frame

There are two connection options between hanging beam and the cabinet :

Option 1, the hanging beam is aligned with a single cabinet;
 Option 2, dislocation installation across two cabinets. Here we recommend the option 2, as shown in Figure 3.1.1.4.



Option 1

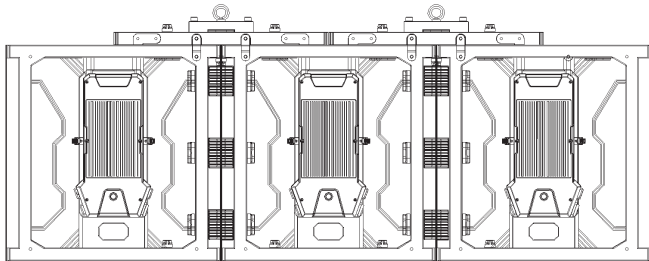

Option 2

Figure 3.1.1.4 Two connection Options of aluminum hanging beam

Based on our testing results, according to the mounting hole selection of each hanging beam, if use 4 hanging beam holes, the load weight is 12000N and security index is 6:1, 200kg, and it is safe within 20 cabinets' height. Therefore, we should pay special attention to choose the quantity of connectors, using 4 pieces of C-connectors, moreover, the connecting piece must be used for the cabinets in a row next to the hanging beam. The C-connector must be inserted in half of hole on the corner of cabinet when two cabinets connected. It is safe to keep the angle between rope and hanging beam to be 85°- 95° in hanging installation. Design sketch is shown as Figure 3.1.1.5 & 3.1.1.6.

Note: When you use hanging rope for hanging installation, please make sure every rope bear the weight even (rope in a tight condition). If the hanging height < 8 cabinets, using two C-connectors between cabinets; if the hanging height ≥ 8 cabinets, the connecting piece must be used.

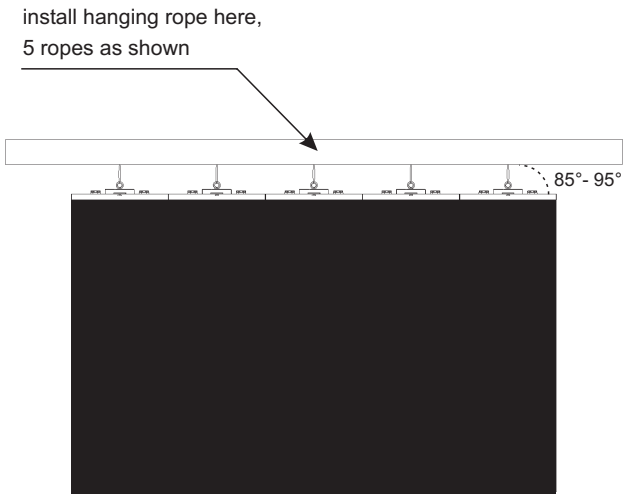

Figure 3.1.1.5 Front side design diagram of hanging installation

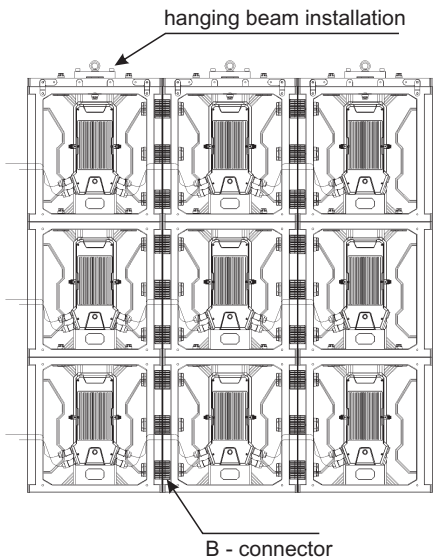
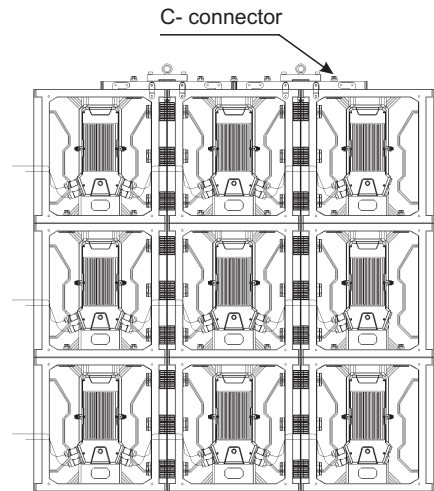

Figure 3.1.1.6 Two installation options of cabinets, design diagram in back side

2. In addition, the hanging beam can also be used as ground support: When the ground is not flat, it can ensure flat installation of the screen, as Figure 3.1.2.1, 3.1.2.2.

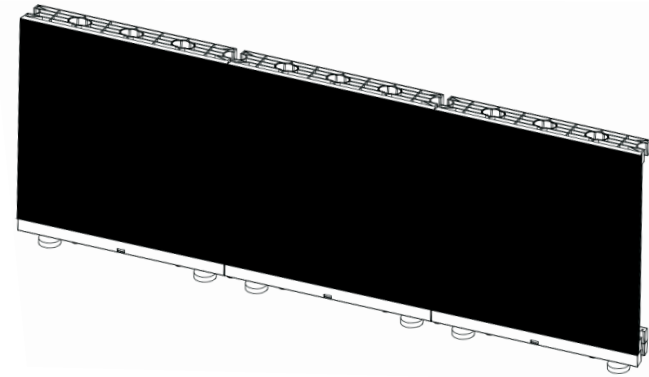

Figure 3.1.2.1 Design diagram of ground support installation in front side

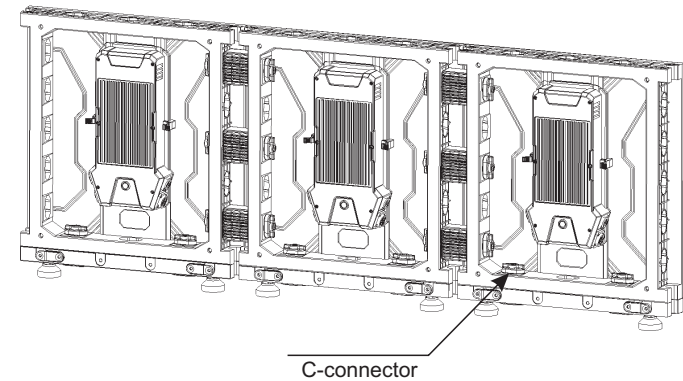

Figure 3.1.2.2 Design diagram of ground support installation in back side

3.2 Fixing installation

Fixing installation means that the cabinet is attached to the wall or steel frame, fixed by connectors. The wall must be safe and firm. Using the connectors between cabinets and fixing on steel frame, which is fixed in the wall, to ensure the firmness.

The difference between fixing installation and hanging installation is the former uses connector (D-connector as Figure 2.1.1) fixing on steel pole rather than through hanging beam. B-connectors must be installed by 3 pieces for each cabinet, D-connectors must be installed by 1 pieces/sqm, as Figure 3.2.1, 3.2.2.

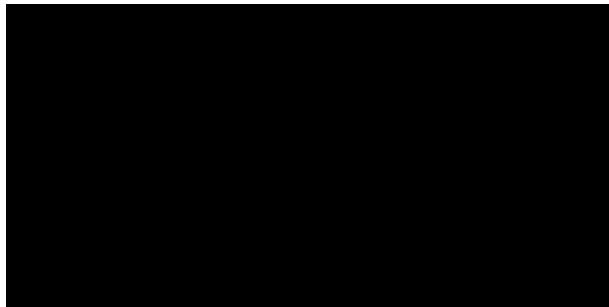

Figure 3.2.1 Design diagram of fixing installation in front side

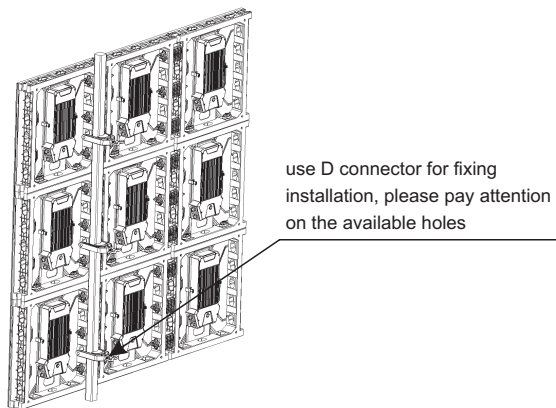

Figure 3.2.2 Design diagram of fixing installation in back side

3.3 Curving installation

Curving installation adopts special connector to connect cabinet with each other, by twisting the connector angles to form arc screen.

Curving installation of LED screen is formed by using the curve connector which can be twisted (show as Figure 2.1.1A - connector). Client can install the cabinet in concave, convex and "S" shape according to their requirements.

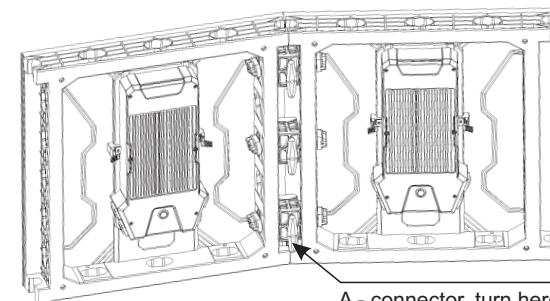
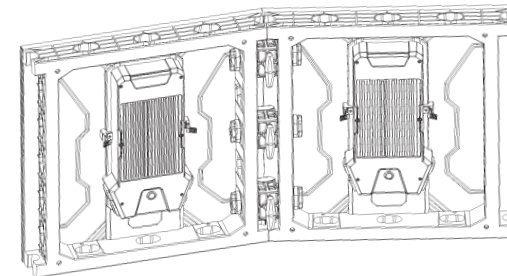
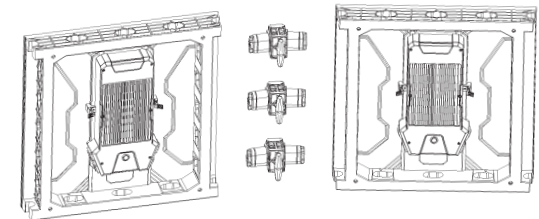

Figure 3.3.1 Curving installation diagram

As shown in Figure 3.3.1, install two cabinets as curved screen: Use A - connector, after ensure the cabinet surface is smooth, then twist two ends of A - connector, and then tighten the above butterfly screw Figure 3.3.2 Top view of concave, convex and "S" shape.

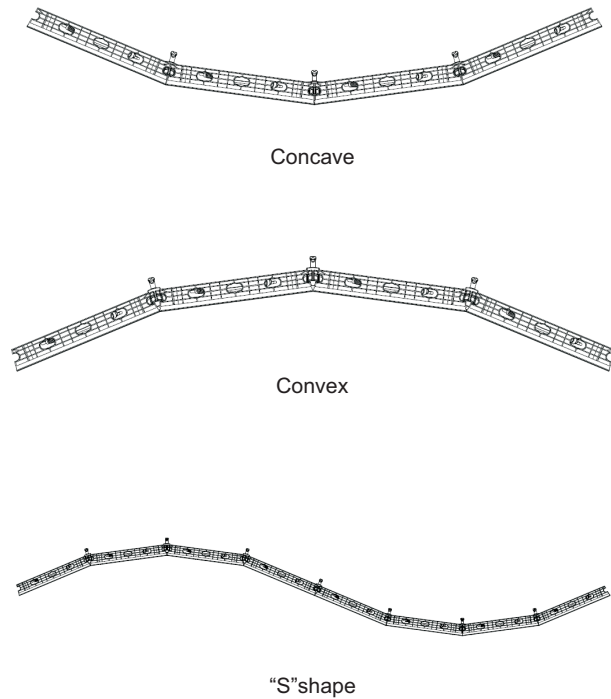

Figure 3.3.2 Top view of curving installation

3.4 Dislocation Installation

Compared to traditional LED screen, MG7S is designed with multiple dislocation mounting holes, providing a great possibility for customers' creative installation. The dislocation installation of Horizontal, Vertical, front&back all can be achieved. However, before the special shaped installation, it is necessary to remove the C-connector to meet the installation of different positions. Different installation chooses different holes, see the details as Figure 3.4.1-3. 4. 3.

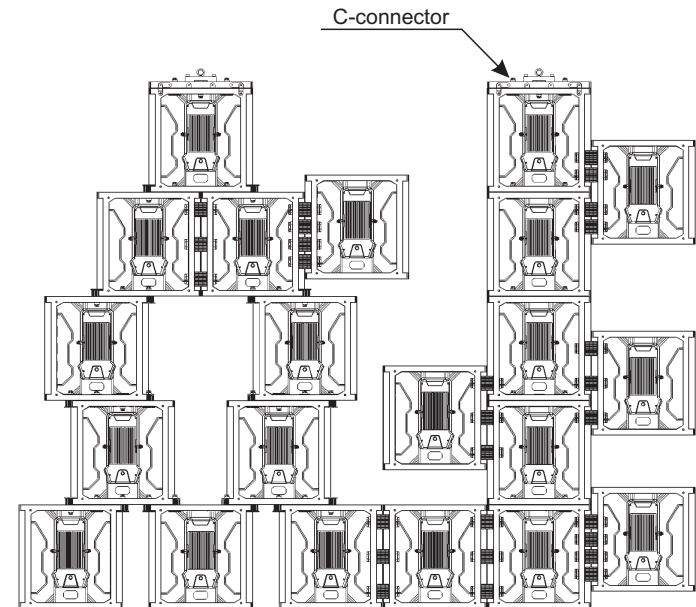

Figure 3.4.1 Horizontal/Vertical dislocation installation (creative design)

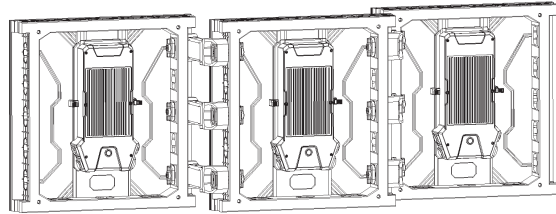

Figure 3.4.2 Front&back dislocation installation 1 (creative design)

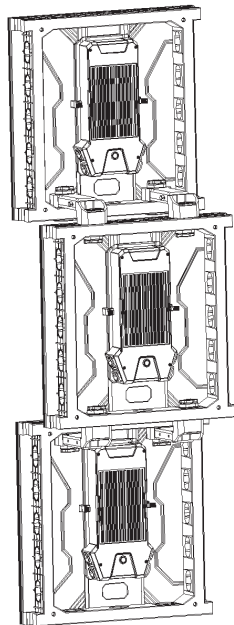

Figure 3.4.3 Front&back dislocation installation 2 (creative design)

3.5 Dance Floor Installation

MG7S cabinet use with Multi-function mounting frame for dance floor installation, like Figure 3.5.1 components for dance floor truss.

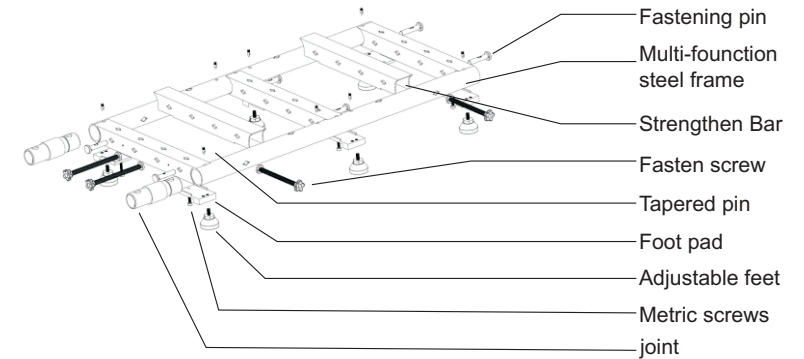

Figure 3.5.1 Components for dance floor truss

Using joint to connect multi-function steel frame, the LOGO side need to be face up, using fasten screw to fixing left, right, up and down of multi-function steel frame. When finishing dance floor truss, adjust the ground adjustable feet to make the dance floor truss more flat with ground. Than install the screen. Figure 3.5.2 dance floor truss installation.

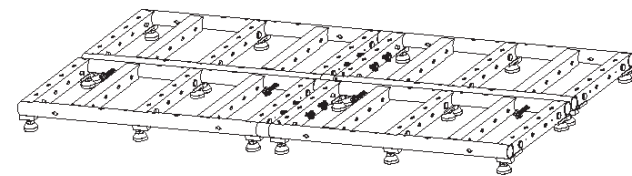

Figure 3.5.2 Dance floor truss installation

When fixing multi-function steel frame fixing with adjustable feet, please be noticed the foot pad must be fully in contact with multi-function steel frame mounting plane, using fastening pin and metric screws fixing the foot pad, make sure that hexagonal wrench is effective to adjust the adjustable feet's height from the front. As Figure 3.5.3.

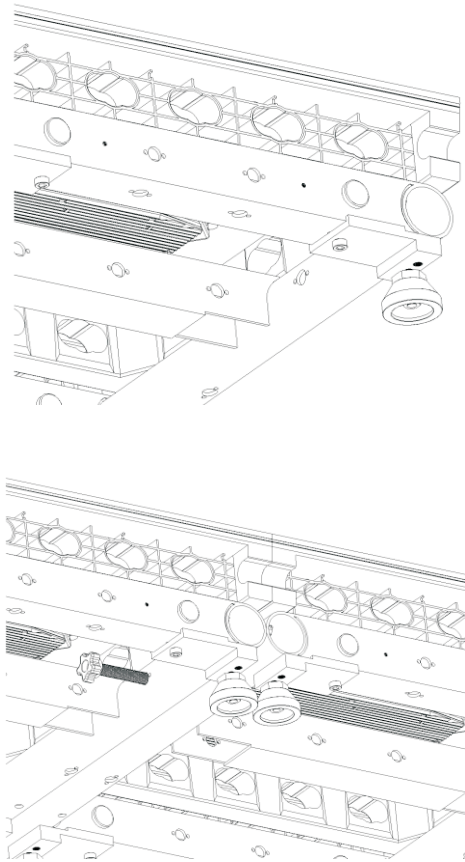

Figure 3.5.3 Multi-function steel frame fixing with adjustable feet

As Figure 3.5.4, when putting the cabinet on the multi-function steel frame, The middle of the cabinet corresponds to the multi-function steel frame need to assemble the strengthen bar, using tapered pin to install in the electrostatic discharge holes on the back of the cabinet, than mounting the cabinet on the dance floor truss. You can easily take out the cabinet with exclusive suction devices.

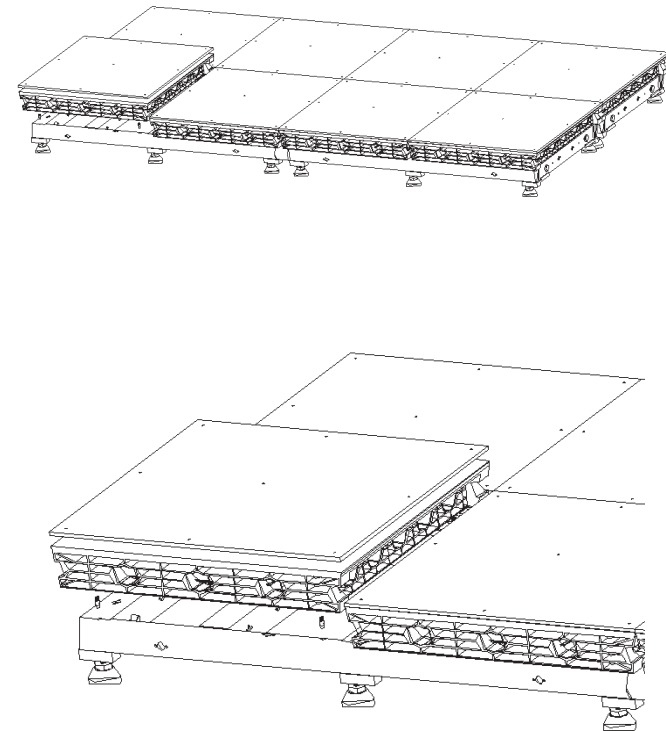

Figure 3.5.4 Cabinet fixing with dance floor truss

Four corners and intermediate position of multi-function steel frame must install the adjustable feet. The adjacent multi-function steel frame shall be fastened by joint and fasten screw. Screen surface shall use 500*500mm dance floor mask to protect.

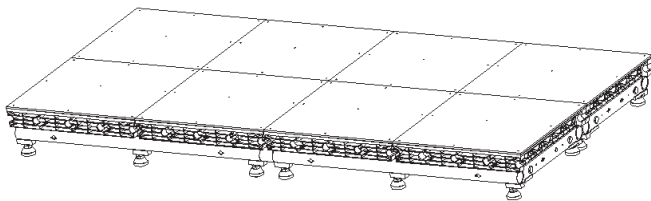
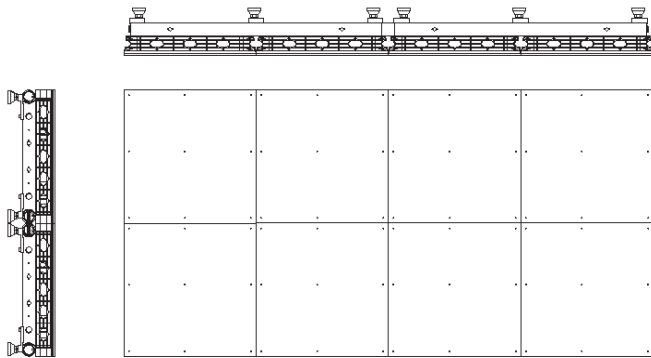

Figure 3.5.5 dance floor with horizontal level adjustment function (with multi-function mounting frame)

When putting the cabinet directly on the floor for the dance floor using. Floor flatness must meet the requirements of dance floor use (floor flatness plus or minus 2MM, floor strength> C25), otherwise it will affect the screen display and damage the components of the cabinet.

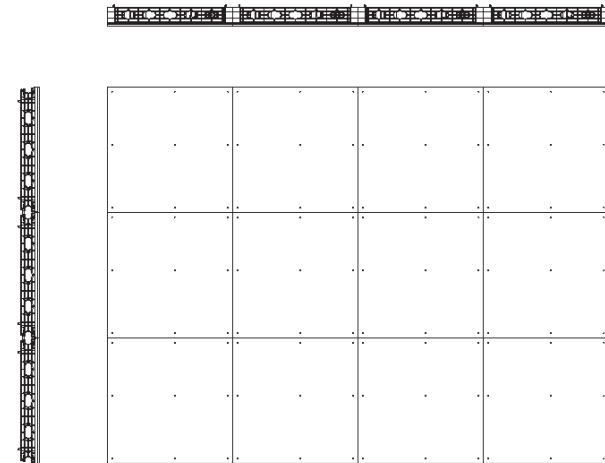

Figure 3.5.6 Dance floor without horizontal level adjustment function (without multi-function mounting frame)

MG7S dance floor panel safety bearing parameter description

500*500mm 6.5mm thickness dance floor mask Extreme pressure and recommended bearing wheel force size and area

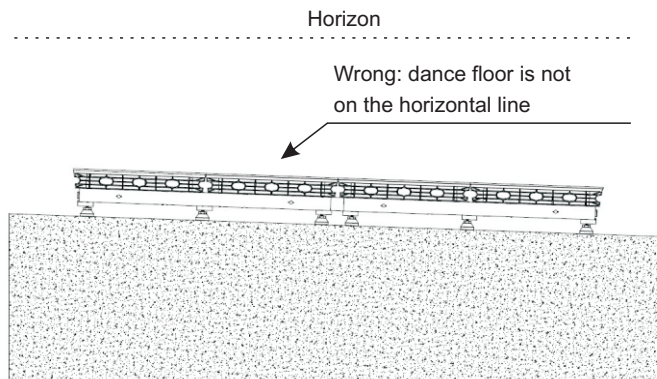
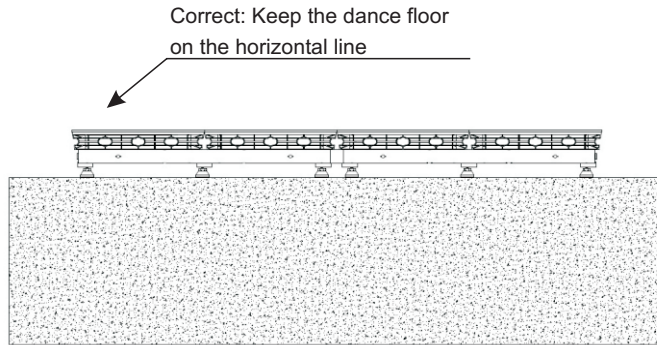

Figure 3.5.7 Dance floor should be kept in horizontal installation

No	Extreme pressure (N)	Force area (sqm)	Ultimate pressure (Pa)	Safety factor	Bearing weight (Kg)	Bearing pressure (N)
1	22000	0.00188	1. 17E+07	6	100	1000
2	22000	0.00188	1. 17E+07	6	200	2000
3	22000	0.00188	1. 17E+07	6	300	3000
4	22000	0.00188	1. 17E+07	6	400	4000
5	22000	0.00188	1. 17E+07	6	500	5000
6	22000	0.00188	1. 17E+07	6	600	6000
7	22000	0.00188	1. 17E+07	6	700	7000
8	22000	0.00188	1. 17E+07	6	800	8000
9	22000	0.00188	1. 17E+07	6	900	9000
10	22000	0.00188	1. 17E+07	6	1000	10000
11	45000	0.02	2. 25E+06	6	1100	11000
12	45000	0.02	2. 25E+06	6	1200	12000
13	45000	0.02	2. 25E+06	6	1300	13000
14	45000	0.02	2. 25E+06	6	1400	14000
15	45000	0.02	2. 25E+06	6	1500	15000
16	45000	0.02	2. 25E+06	6	1600	16000
17	45000	0.02	2. 25E+06	6	1700	17000
18	45000	0.02	2. 25E+06	6	1800	18000
19	45000	0.02	2. 25E+06	6	1900	19000
20	45000	0.02	2. 25E+06	6	2000	20000
21	45000	0.02	2. 25E+06	6	2100	21000

MG7S dance floor panel safety bearing parameter description

500*500mm 6.5mm thickness dance floor mask Extreme pressure and recommended bearing wheel force size and area

Total force area	Wheels quantity	Wheel force area length (m)	Wheel force area width (m)	Single wheel force area (m ²)
0.000512727	4	0.011321741	0.011321741	0.000128182
0.001025455	4	0.01601136	0.01601136	0.000256364
0.001538182	4	0.019609831	0.019609831	0.000384545
0.002050909	4	0.022643482	0.022643482	0.000512727
0.002563636	4	0.025316182	0.025316182	0.000640909
0.003076364	4	0.027732488	0.027732488	0.000769091
0.003589091	4	0.029954511	0.029954511	0.000897273
0.004101818	4	0.032022719	0.032022719	0.001025455
0.004614545	4	0.033965223	0.033965223	0.001153636
0.005127273	4	0.035802488	0.035802488	0.001281818
0.029333333	4	0.085634884	0.085634884	0.007333333
0.032	4	0.089442719	0.089442719	0.008
0.034666667	4	0.093094934	0.093094934	0.008666667
0.037333333	4	0.096609178	0.096609178	0.009333333
0.04	4	0.1	0.1	0.01
0.042666667	4	0.103279556	0.103279556	0.010666667
0.045333333	4	0.106458129	0.106458129	0.011333333
0.048	4	0.109544512	0.109544512	0.012
0.050666667	4	0.112546287	0.112546287	0.012666667
0.053333333	4	0.115470054	0.115470054	0.013333333
0.056	4	0.118321596	0.118321596	0.014

Chapter 4 Frequently Questions For LED Screen

4.1 Software Questions

1.Connection interruption or prompt unable to find the control card when starting the software, or the interface of the software is not adjustable, that is,gray status, and there is no main controlling icon of the software LED control equipment list.

Solution:

- ① Change USB cable.
- ② Check the equipment connection in the equipment manager.
- ③ Ensure that the computer is no virus.
- ④ If it is the internal sending card , it is probably due to the loose slot or damaged PCI, or the interference of foreign matter. Please insert sending card again or clean PCI interface by rubber.

2. Indicator light of the output port for sending card is extinguished.

Solution:

- ① Relevant control software has not been installed, please ensure the software is successfully installed .
- ② The FPD of the graphics card is closed. Please right click "my computer" on the desktop, and then click properties-> setting-> advanced> display-> FPD.

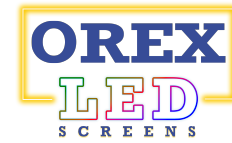

Chapter 5 LED Screen Maintenance

Proper use of the LED screen is very important for the long lifespan of the LED screen and the proper function. Daily maintenance of the LED screen must be finished carefully.

4.2 Hardware Questions

1. There is no content on the LED screen.

Solution:

- a. Check whether the screen is powered on.
- b. Check whether the output signal is open.
- c. Check whether display area is correct.

2. The cabinet of the LED screen is blurred or not bright enough in certain cabinets.

Solution:

- a. Check whether modules and HUB card is connected.
- b. Check whether the configuration file is uploaded correctly.
- c. Check whether the calibration is open or correct.
- d. Please change the broken masks if there is.

3. The picture of the cabinet is in a wrong order.

Solution: Please check the inner connection of each LED module to see if cables are well connected.

4. Some individual LED lamps are extinguished.

Solution: Please repair these dead LEDs.

1. Please read the MG7 series LED Screen User Manual carefully. The manufacturer do not take any legal liability of the consequence due to the incorrect, incomplete, irresponsible, or unsafe use of the installation system.

2. Handle the LED screen cabinet with care, avoid collision and strike.

3. Check the cabinet carefully to make sure there is no loose screw before using.

4. Please confirm the steel frames are kept in place firmly before installation, for the screen already been installed for a long time, regular checking the situation of the connection part is required. If found any loose part, adjust it timely, reinforce or change new hanging parts in time.

5. Keep the whole cabinet frame structure away from oil, acid and other corrosive material.

6. Pay attention to the anti-static work of the screen body, do not touch the LED face directly by hand, wearing gloves when you install and debugging of the screen is recommended.

7. Null line and firing line of the power cable in a computer or the control system can't be connected reversely, It should be connected strictly according to the original position.

8. If the power switch trip happened frequently, please check the screen or replace the power supply switch.



9. Before lighting the screen, turn on the PC first, then turn on the LED screen. When stopping work of the screen, first turn off the LED screen, then turn off the PC (otherwise, it will cause the screen highlights, burn the lamp, the consequences are serious).

10. If there is short circuit, switch trip, wire burning, smoke and other abnormal phenomenon after removing, please don't repeat electricity test, and check the problem timely.

11. The proper way to remove a power supply: turn the cabinet back up and keep the connector upward; loosen the screws on aluminum cooling board and lift the aluminum cooling board up horizontally to 30 ~ 40mm (meanwhile observing the power supply box interior), overturn the aluminum cooling board to right slowly (Attention to prevent radiator's fan crashing other component), then start checking and repairing.

12. Master the installation method, the original data recovery, backup, and controlling parameter setting, basic data preset modification.

13. Inspect virus regularly, and remove irrelevant data.

14. Software operation is under professional engineers.

15. Please do not perform in the storm(rain, dust) and strong wind;

16. Dismantle the LED screen after the events, please clean the water stains and dust on the two sides of each cabinet before putting them into the flight case, the internal space of flight case must be clean and dry, if there is moist , you must dry them in the sun, or dry it with the dryer. At the same time, too much friction should be avoided between cabinet and inner part of the flight case.

17. When installing and removing the LED screen, special attention must be paid to the protection of the LEDs on the four sides of the LED cabinet to prevent LEDs from damage.

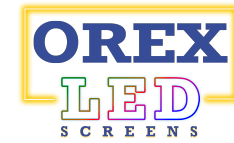

18. Regarding the maintenance of the connectors:

a. Fill the cleaning liquid to the cleaner guns, such as DJW-618X cleaning liquid (Major element is: Dichloroethane, Trichloroethane or ethyl Alcohol).

b. Pointing the cleaner guns in a 45 degree, distance around 10-15cm, pointing to the dirty area of the connectors, press the switch , spot-spray clean the dirty area.

Attentions about cleaning the connectors:

a. Cleaner gun is high pressure, pointing to the people is very dangerous. Please keep it in a high position after use.

b. Please wear mask and protection glass, to avoid the cleaning liquid splash into the human eyes and mouth.

c. Cleaning work should be kept far away from fire. Firework is prohibited.

d. Cleaning work should be arranged in a natural ventilation atmosphere, or the open area.

19. Outdoor display not only need to consider the wet problem, but also to do waterproof, dust proof and other routine maintenance work; good sealed installation can help the LED screen to reduce the risk of water go inside. Regular cleaning attached to the dust of inside and outside the screen also help LED screen better heat dissipation, reduce the water vapor attached;

20. Wet and rainy weather can cause the dew on the wall, please keep the cabinet away from the wet wall, to avoid contact with the dew on the wall.

21. Please keep the LED screen storage warehouse to be well ventilated, dry environment is a must. You can't let the wet weather inside the warehouse, please choose the high and dry location.